

# OSP-013

Ordering lot : 200pcs.

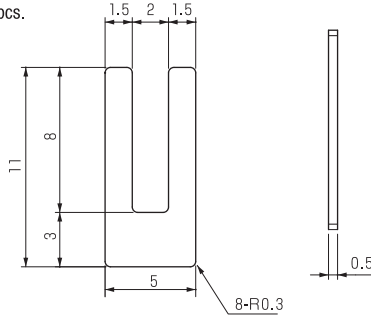

Rated Current 6A / For 3.81mm (terminal to terminal) models

● Applicable Terminal Block Models

OS-8E	OS-8F	OS-85
OS-86	OS-95	OS-96

Material	Brass (t=0.5mm)
Surface Treatment	Ni

# OSP-205

Ordering lot : 50pcs.

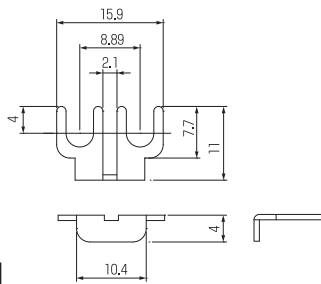

Rated Current 10A / For 8.89mm (terminal to terminal) models

● Applicable Terminal Block Models

OTB-130	OTB-190N	OTB-710
OTB-711	OTB-712	OTB-720
OTB-721	OULS-2050	OULS-2053

Material	Brass (t=0.8mm)
Surface Treatment	Ni

**OSP-205-COAT** (With insulation coating)  
Ordering lot : 1000pcs.

# OV-762R

Ordering lot : 50pcs.

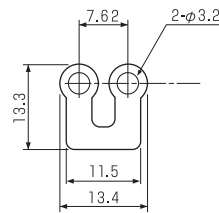

Rated Current 15A / For 7.62mm (terminal to terminal) models

● Applicable Terminal Block Models

OBU-553	OBU-553L	OTB-136
OTB-136N	OTB-137	OTB-137N
OTB-138	OTB-138N	OTB-576
OTB-60	OTB-701	OTB-750
OTB-750N	OTB-751	OTB-753
OTB-754	OTB-755	OTB-755N
OTB-4068	OTB-6250	OTB-6251
OULS-4055		

Material	Brass (t=0.6mm)
Surface Treatment	Ni

# OV-762

Ordering lot : 50pcs.

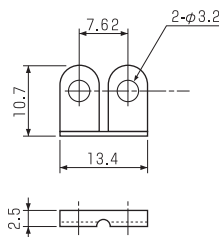
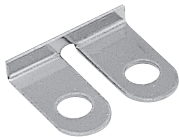

Rated Current 15A / For 7.62mm (terminal to terminal) models

● Applicable Terminal Block Models

OBU-553	OBU-553L	OTB-58
OTB-136	OTB-136N	OTB-137
OTB-137N	OTB-138	OTB-138N
OTB-192	OTB-576	OTB-60
OTB-701	OTB-750	OTB-750N
OTB-751	OTB-753	OTB-755
OTB-755N	OTB-4068	OULS-4055

Material	Brass (t=0.5mm)
Surface Treatment	Ni

# OV-762F

Ordering lot : 50pcs.

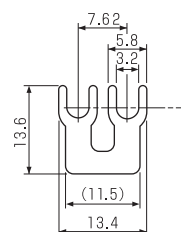
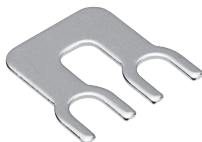

Rated Current 15A / For 7.62mm (terminal to terminal) models

● Applicable Terminal Block Models

OBU-553	OBU-553L	OTB-136
OTB-136N	OTB-137	OTB-137N
OTB-138	OTB-138N	OTB-192
OTB-576	OTB-701	OTB-750
OTB-750N	OTB-751	OTB-753
OTB-754	OTB-755	OTB-755N
OTB-4068	OTB-6250	OTB-6251
OULS-4055		

Material	Brass (t=0.6mm)
Surface Treatment	Ni

# OSP-064

Ordering lot : 50pcs.



Material	Brass (t=0.5mm)
Surface Treatment	Ni

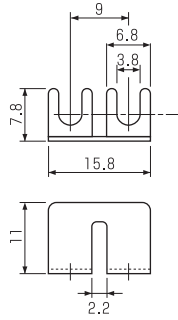

Rated Current 15A / For 9mm (terminal to terminal) models

● Applicable Terminal Block Models

OTB-6300	OULK-702
----------	----------

# OV-889

Ordering lot : 50pcs.

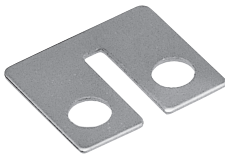

Material	Brass (t=0.5mm)
Surface Treatment	Ni

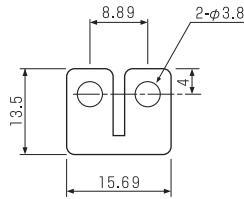

Rated Current 20A / For 8.89mm (terminal to terminal) models

● Applicable Terminal Block Models

OTB-130	OTB-190N	OTB-710
OTB-711	OTB-712	OTB-720
OTB-721	OULS-2050	OULS-2053

**OV-889-COAT** (With insulation coating)  
Ordering lot : 1000pcs.

# OSP-010

Ordering lot : 50pcs.



Material	Brass (t=0.6mm)
Surface Treatment	Ni

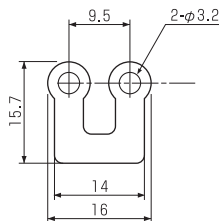

Rated Current 20A / For 9.5mm (terminal to terminal) models

● Applicable Terminal Block Models

OTB-113(M3)	OTB-115(M3)	OTB-116(M3)
OTB-550	OTB-551	OTB-760(M3)
OTB-761(M3)	OTB-763(M3)	

# OSP-095

Ordering lot : 50pcs.



Material	Brass (t=0.6mm)
Surface Treatment	Ni

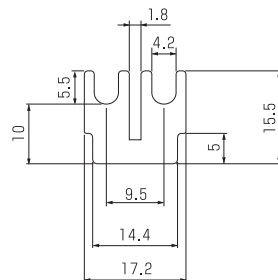

Rated Current 20A / For 9.5mm (terminal to terminal) models

● Applicable Terminal Block Models

OTB-113	OTB-115	OTB-116
OTB-45	OTB-46	OTB-701
OTB-760	OTB-763	

**OSP-095-COAT** (With insulation coating)  
Ordering lot : 1000pcs.

# OH-10

Ordering lot : 50pcs.



Material	Brass (t=0.8mm)
Surface Treatment	Ni

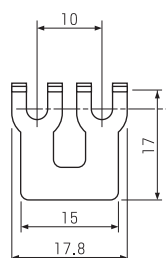

Rated Current 20A / For 10mm (terminal to terminal) models

● Applicable Terminal Block Models

OTB-125(M3)	OTB-126(M3)	OTB-129
OTB-725(M3)	OTB-726(M3)	OTB-770(M3)
OTB-771(M3)	OTB-6220(M3)	OULS-2070(M3)

# OH-10S

Ordering lot : 50pcs.

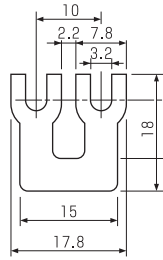

Rated Current 20A / For 10mm (terminal to terminal) models

● Applicable Terminal Block Models

OTB-125(M3)	OTB-126(M3)	OTB-129
OTB-725(M3)	OTB-726(M3)	OTB-770(M3)
OTB-771(M3)	OTB-6220(M3)	OULS-2070(M3)

Material	Brass (t=0.8mm)
Surface Treatment	Ni

# OSP-094M

Ordering lot : 50pcs.

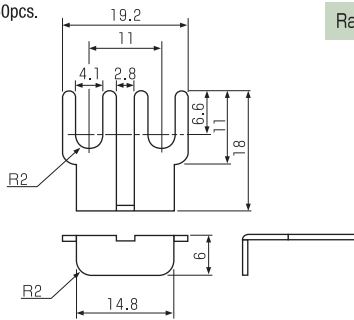

Rated Current 20A / For 11mm (terminal to terminal) models

● Applicable Terminal Block Models

OTB-640N	OTB-640NS	OULP-947
OULP-948		

Material	Brass (t=0.6mm)
Surface Treatment	Ni

# OSP-094R

Ordering lot : 50pcs.

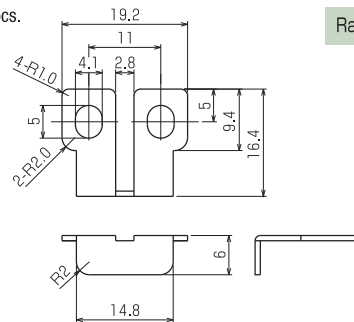

Rated Current 20A / For 11mm (terminal to terminal) models

● Applicable Terminal Block Models

OTB-640N	OTB-640NS	OULP-947
OULP-948		

Material	Brass (t=0.8mm)
Surface Treatment	Ni

# OSP-009

Ordering lot : 50pcs.

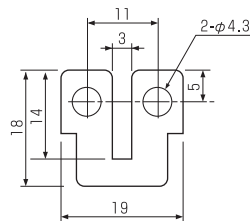

Rated Current 20A / For 11mm (terminal to terminal) models

● Applicable Terminal Block Models

OTB-120	OTB-121	OTB-128
OTB-166N	OTB-306N	OTB-307N
OTB-525	OTB-780	OTB-781
OTB-782	OGM-300	OGM-300NE
OTB-640N		

Material	Brass (t=0.8mm)
Surface Treatment	Ni

# OJ-11

Ordering lot : 50pcs.

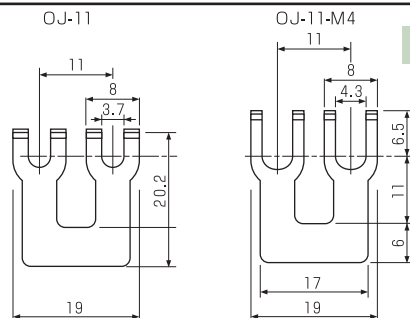
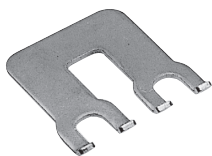

Rated Current 30A / For 11mm (terminal to terminal) models

● Applicable Terminal Block Models (OJ-11)

OFA-01N	OTB-600	OTB-6222
---------	---------	----------

(Att) The point part in the bar is straight. OJ-11-S

● Applicable Terminal Block Models (OJ-11-M4)

OTB-541	OTB-542	OTB-731N
OTB-800N	OTB-802N	OK-020

Material	Brass (t=0.8mm)
Surface Treatment	Ni

# OT-11A

Ordering lot : 50pcs.

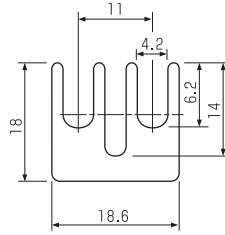

Rated Current 30A / For 11mm (terminal to terminal) models

● Applicable Terminal Block Models

OTB-900	OULP-930	OULP-936
OULP-947	OULP-948	OGM-300
OGM-300NE		

**OT-11A-COAT** (With insulation coating)

Ordering lot : 1000pcs.

Material	Brass (t=1.0mm)
Surface Treatment	Ni

# OSP-033

Ordering lot : 50pcs.

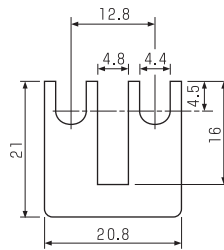
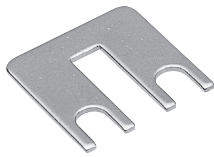

Rated Current 30A / For 12.8mm (terminal to terminal) models

● Applicable Terminal Block Models

OTB-240
---------

Material	Brass (t=1.0mm)
Surface Treatment	Ni

# OSP-018

Ordering lot : 50pcs.

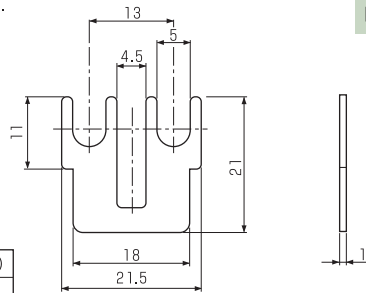
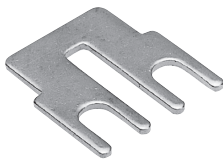

Rated Current 30A / For 13mm (terminal to terminal) models

● Applicable Terminal Block Models

OTB-180	OTB-181	OTB-330N
OTB-916	OTB-3013	

Material	Brass (t=1.0mm)
Surface Treatment	Ni

# OSP-16

Ordering lot : 50pcs.

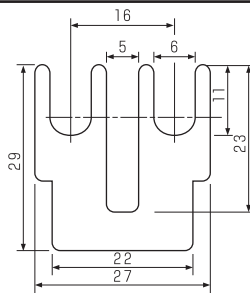
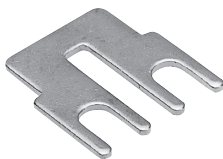

Rated Current 60A / For 16mm (terminal to terminal) models

● Applicable Terminal Block Models

OTB-315N	OTB-358	OTB-358N
OTB-910	OTB-913	OTB-917
OK-060		

Material	Brass (t=1.2mm)
Surface Treatment	Ni

# OSP-147

Ordering lot : 50pcs.

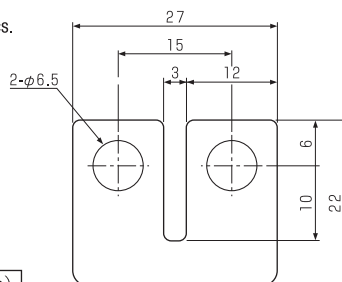

Rated Current 80A / For 15mm (terminal to terminal) models

● Applicable Terminal Block Models

OK-050
--------

Material	Brass (t=1.5mm)
Surface Treatment	Ni

# OSP-358 OSP-320

Ordering lot : 50pcs.



Material	Brass (t=2.0mm)
Surface Treatment	Ni

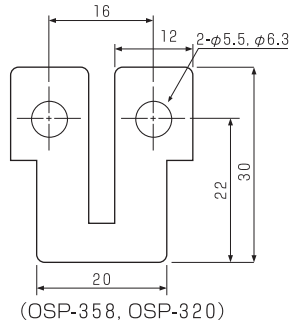

Rated Current 85A / For 16mm (terminal to terminal) models

● Applicable Terminal Block Models  
OSP-358

OTB-315N	OTB-358	OTB-358N
OTB-358MS	OTB-910	OTB-913
OTB-911	OK-060	

OSP-320 φ6.3  
OTB-359

**OSP-358-COAT** (With insulation coating)  
Ordering lot : 1000pcs.

# OSP-388

Ordering lot : 50pcs.



Material	Brass (t=2.0mm)
Surface Treatment	Ni

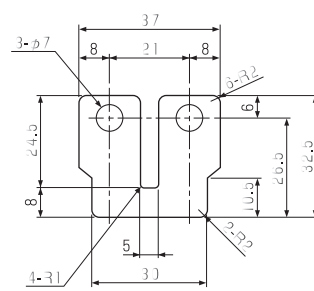

Rated Current 130A / For 21mm (terminal to terminal) models

● Applicable Terminal Block Models

OTB-388	OTB-390
---------	---------

**OSP-388-COAT** (With insulation coating)  
Ordering lot : 1000pcs.

# OSP-1500

Ordering lot : 50pcs.



Material	Brass (t=1.5mm)
Surface Treatment	Ni

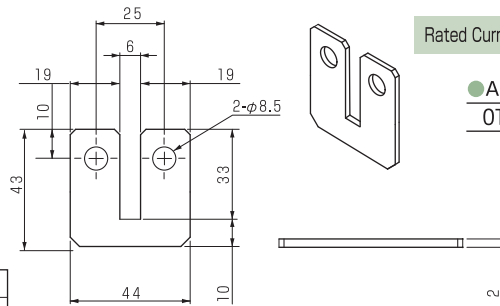

Rated Current 130A / For 25mm (terminal to terminal) models

● Applicable Terminal Block Models

OTB-1500
----------

**OSP-1500-COAT** (With insulation coating)  
Ordering lot : 1000pcs.

# OSP-048L

Ordering lot : 50pcs.



Material	Brass (t=2.0mm)
Surface Treatment	Ni

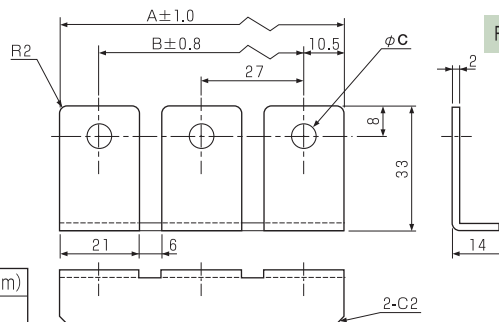

Rated Current 150A / For 27mm (terminal to terminal) models

● Applicable Terminal Block Models

OTB-488	OTB-489	OTB-490
OK-0100		

**OSP-048L-COAT** (With insulation coating)  
Ordering lot : 1000pcs.

Measurements List of A, B & φC  
(P : Number of terminals)

P	1	2	3	φC	
A	48	75		φ6.5	φ8.5
B	27	54			