

# LINEAR HALL EFFECT FINGER JOYSTICK

**HTL**  
HALL EFFECT  
JOYSTICK

## 2 & 4-WAY LINEAR HALL EFFECT FINGER JOYSTICK



HTL4 with External  
Castle Boot Style  
Button



HTL2 with Tall  
Concave Stadium  
Boot Style Button

The HTL series provides all of the performance of a full size, dual axis joystick in a miniature package that can be mounted in control handles, armrests and panels. The Hall effect sensors are immune to electromagnetic and radio frequency interference up to 100V/M. Programmable sensors with built-in temperature compensation ensure consistent and repeatable operation. The HTL series has excellent tactile feel for improved operator control and is available with either dusttight or IP68S watertight seal. A wide variety of output configurations are available to satisfy different applications.

### Features:

- Designed for grip, armrest & panel mounting
- Proven contactless analog output Hall effect technology
- Redundant outputs available
- 1 million cycles
- Electronics watertight to IP68S
- Outstanding EMI/RFI immunity
- Variety of button styles
- Tighter center tolerance options
- RoHS/WEEE/Reach compliant

### Standard Characteristics/Ratings:

#### MECHANICAL:

**Mechanical Life:** 1,000,000 all directions

**Travel Angle:** 23° min to 27° max, 25° typical

**Operating Force with Boot:** 16 oz typical to 20 oz max (at top of button) @ 20°C

**Max Allowable Vertical & Radial Force on Button:** 25.0 lbs.

**Max Allowable Torque on Button about Shaft Axis:** 5.5 lbs.

#### ELECTRICAL RATINGS:

**HTL2: Rated at Vcc = 5V @ 20°C Load = 1mA (4.7KΩ)**

Electrical	Units	Min	Typ	Max
Supply Voltage	VDC	4.50	5.00	5.50
Output Voltage Tolerance at Center AA, BB, CC, DD, EE, FF, GG & HH @ 5V Vcc	VDC	-0.25	N/A	+0.25
Output Voltage Tolerance at Center AT, BT, CT, DT, ET and FT @ 5V Vcc	VDC	-0.15	N/A	+0.15
Output Voltage Tolerance at Full Travel (see graph for output values) @ 5V Vcc	VDC	-0.25	N/A	+0.25
Supply Current per Sensor B=0, Vcc=5V, Iout=0	mA	N/A	N/A	10.00
Output Source Current Limit B=-X*, Vo=0	mA	-1.00	N/A	1.00
Output Resistance (Io ≤ 2mA)	Ω	N/A	1.00	10.00

**HTL4: Rated at Vcc = 5V @ 20°C Load = 1mA (4.7KΩ)**

Electrical	Units	Min	Typ	Max
Supply Voltage	VDC	4.50	5.00	5.5
Output Voltage Tolerance at Center AA, BB, CC, DD, EE, FF, GG & HH @ 5V Vcc	VDC	-0.25	N/A	+0.25
Output Voltage Tolerance at Center AT, BT, CT, DT, ET and FT @ 5V Vcc	VDC	-0.15	N/A	+0.15
Output Voltage Tolerance at Full Travel (see graph for output values) @ 5V Vcc	VDC	-0.25	N/A	+0.25
Supply Current per Sensor B=0, Vcc=5V, Iout=0	mA	N/A	N/A	10.00
Output Source Current Limit B=-X*, Vo=0	mA	-1.00	N/A	1.00

#### ELECTRONICS

**Seal Integrity:** Electronics IP68S

#### ENVIRONMENTAL:

**Operating Temp Range:** -40°C to +85°C

**Storage Temp Range:** -40°C to +85°C

**RFI:** Withstand per SAE J1113

**EMI:** Withstand per SAE J1113

#### MATERIALS:

**Boot:** Elastomer

**Button:** Thermoplastic, black

**Case:** Thermoplastic, black

**Flange:** Thermoplastic, black

**Wires:** 22 or 24 AWG

**Mounting Hardware:** Panel fastener assembly

# LINEAR HALL EFFECT FINGER JOYSTICK

## 2 & 4-WAY LINEAR HALL EFFECT TOGGLE

### HTL2 PART NUMBER CODE

HTL2	-	X	X	X	X	X	XX	X	X
Button Style	Case Style	Seal	Travel	Detent	Operating Force	Output 1 ①	Output 2 ②	Termination	Button Color
1. Castle	1. 0.970" SQ.	1. Dusttight	1. 25°	1. None	1. 16 oz	AA. 2.5 +/- 2.0VDC	NONE	1. Wire Leads	2. Black
2. External Castle Boot		2. Watertight*		2. Detent at 50% travel (not available with button style 7)		BB. 2.5 +/- 2.0VDC	2.5 +/- 2.0VDC	22 AWG, UL 1569	
3. Short Double Stadium						CC. 2.5 +/- 2.0VDC	2.5 +/- 2.0VDC	2. Pins	
4. Tall Concave Stadium						DD. 2.5 +/- 1.5VDC	NONE	3. Wire Leads	
5. External Bat Handle Boot						EE. 2.5 +/- 1.5VDC	2.5 +/- 1.5VDC	24 AWG, SAE AS22759	
6. External Smooth Boot						FF. 2.5 +/- 1.5VDC	2.5 +/- 1.5VDC		
7. Long Concave Y Axis Button						GG. 0.5 - 4.5VDC	0.5 - 4.5VDC		
8. Low Profile Button						HH. 1.0 - 4.0VDC	1.0 - 4.0VDC		
						AT. 2.5 +/- 2.0VDC	NONE**		
						BT. 2.5 +/- 2.0VDC	2.5 +/- 2.0VDC**		
						CT. 2.5 +/- 2.0VDC	2.5 +/- 2.0VDC**		
						DT. 2.5 +/- 1.5VDC	NONE**		
						ET. 2.5 +/- 1.5VDC	2.5 +/- 1.5VDC**		
						FT. 2.5 +/- 1.5VDC	2.5 +/- 1.5VDC**		

### HTL4 PART NUMBER CODE

HTL4	-	X	X	X	X	X	XX	X	X
Button Style	Case Style	Seal	Travel	Gating***	Operating Force	Output 1 ①	Output 2 ②	Termination	Button Color
1. Castle	1. 0.970" SQ.	1. Dusttight	1. 25°	1. Omnidirectional; Square; On-Axis and Off-Axis Guided Feel	1. 16 oz	AA. 2.5 +/- 2.0VDC	NONE	1. Wire Leads	2. Black
2. External Castle Boot		2. Watertight*		2. Gated; Two Axis Return to Center		BB. 2.5 +/- 2.0VDC	2.5 +/- 2.0VDC	22 AWG, UL 1569	
3. Short Double Stadium				3. Omnidirectional; Round; Smooth Feel		CC. 2.5 +/- 2.0VDC	2.5 +/- 2.0VDC	2. Pins	
4. Tall Concave Stadium				4. Omnidirectional; Round; On-Axis Guided Feel		DD. 2.5 +/- 1.5VDC	NONE	3. Wire Leads	
5. External Bat Handle Boot				5. Omnidirectional; Square; On-Axis and Off-Axis Guided Feel with Detent at 50% Travel		EE. 2.5 +/- 1.5VDC	2.5 +/- 1.5VDC	24 AWG, SAE AS22759	
6. External Smooth Boot				6. Omnidirectional; Round; Smooth Feel with Detent at 50% Travel		FF. 2.5 +/- 1.5VDC	2.5 +/- 1.5VDC	4. Wire Leads	
7. Long Concave Y Axis Button				7. Omnidirectional; Round; On-Axis Guided Feel with Detent at 50% Travel		GG. 0.5 - 4.5VDC	0.5 - 4.5VDC	22 AWG, UL 1569 shared powers and grounds (see schematic)	
						HH. 1.0 - 4.0VDC	1.0 - 4.0VDC	5. Wire Leads	
						AT. 2.5 +/- 2.0VDC	NONE**	24 AWG, SAE AS22759 shared powers and grounds (see schematic)	
						BT. 2.5 +/- 2.0VDC	2.5 +/- 2.0VDC**		
						CT. 2.5 +/- 2.0VDC	2.5 +/- 2.0VDC**		
						DT. 2.5 +/- 1.5VDC	NONE**		
						ET. 2.5 +/- 1.5VDC	2.5 +/- 1.5VDC**		
						FT. 2.5 +/- 1.5VDC	2.5 +/- 1.5VDC**		

\* Watertight sealed option available with button styles 2, 5 and 6.

\*\* Options AT, BT, CT, DT, ET and FT are identical to options AA, BB, CC, DD, EE and FF respectively except with a tighter center tolerance.

\*\*\*Gating options 5, 6 and 7 not available with button style 7.

① Outputs are from the center to the full travel position in each direction. Options "AA," "BB," "CC," "DD," "EE," and "FF" provide increased voltage in +Y; and decreasing voltage in -Y direction from one output per axis with the HTL2 and increased voltage in +X, +Y; and decreasing voltage in -X, -Y direction from one output per axis with the HTL4. Options "GG" and "HH" provide increasing voltages in all directions (+Y, -Y with the HTL2 and +X, +Y, -X, -Y with the HTL4) from 2 outputs per axis.

② Options "BB" and "EE" provide redundant output 2 which duplicates output 1. Options "CC" and "FF" provide redundant output 2 which is inverse of output 1.

### Gating Icons



Omnidirectional Square On-Axis and Off-Axis Guided Feel\*\*\*\*

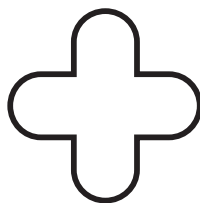

Gated Two Axis Return to Center

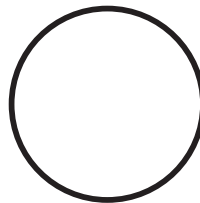

Omnidirectional Round On-Axis Smooth Feel

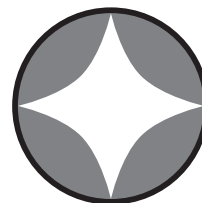

Omnidirectional Round On-Axis Guided Feel\*\*\*\*



Single Axis (HTL2 version)

\*\*\*\*Feel defined by shading.

# LINEAR HALL EFFECT FINGER JOYSTICK

**HTL**  
HALL EFFECT  
JOYSTICK

## 2 & 4-WAY LINEAR HALL EFFECT TOGGLE

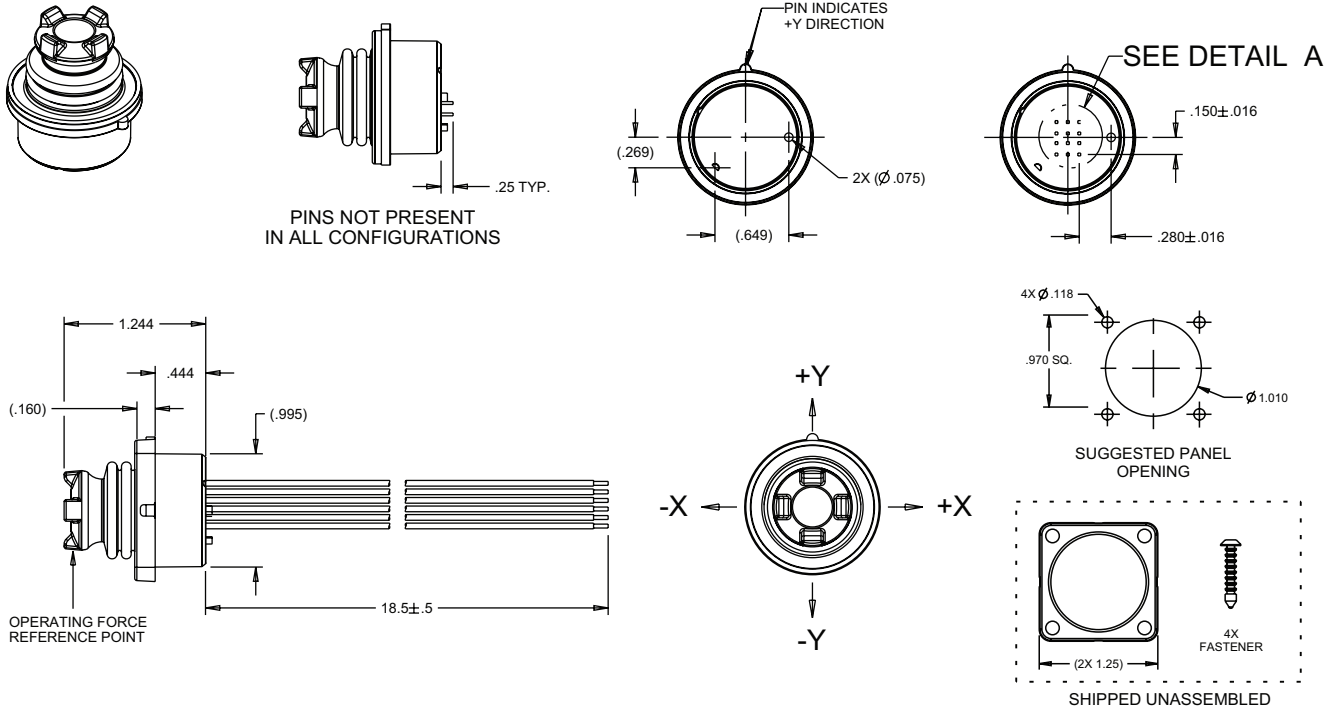

### HTL2 FOOTPRINT

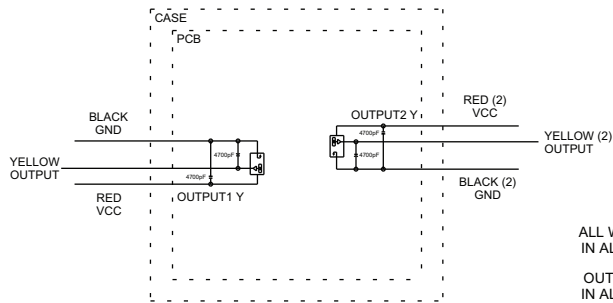

ALL WIRES NOT PRESENT IN ALL CONFIGURATIONS  
OUTPUT2 NOT PRESENT IN ALL CONFIGURATIONS

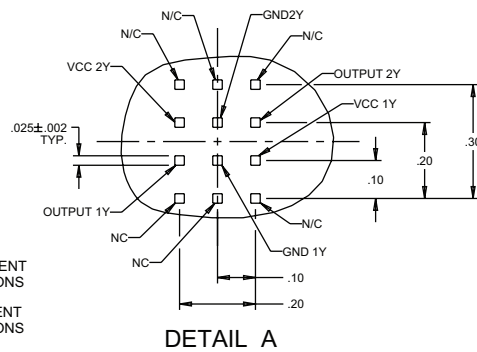

ALL PINS NOT PRESENT IN ALL CONFIGURATIONS

### HTL4 FOOTPRINT

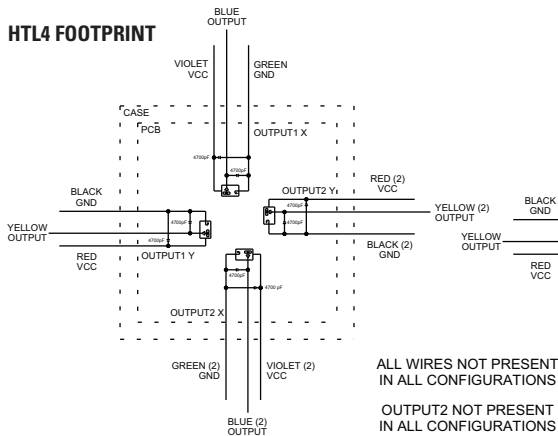

ALL WIRES NOT PRESENT IN ALL CONFIGURATIONS  
OUTPUT2 NOT PRESENT IN ALL CONFIGURATIONS

TERMINATION STYLE 1, 2, AND 3

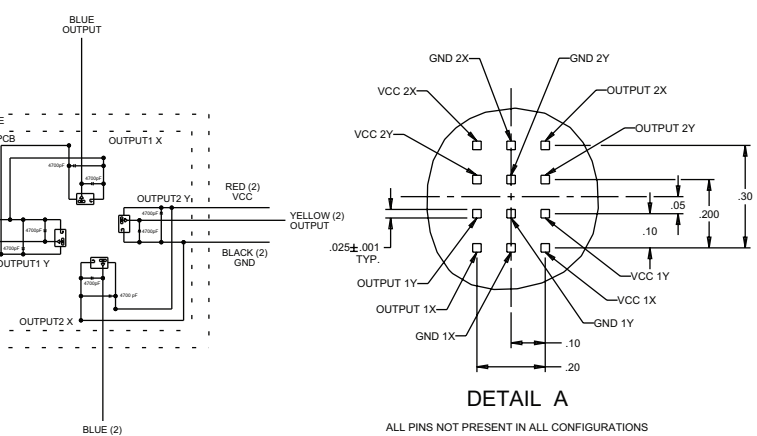

TERMINATION STYLE 4 AND 5

### DETAIL A

ALL PINS NOT PRESENT IN ALL CONFIGURATIONS

HALL EFFECT

## 2 & 4-WAY LINEAR HALL EFFECT TOGGLE

### HTL4 OUTPUTS

**OPTION AA & AT**

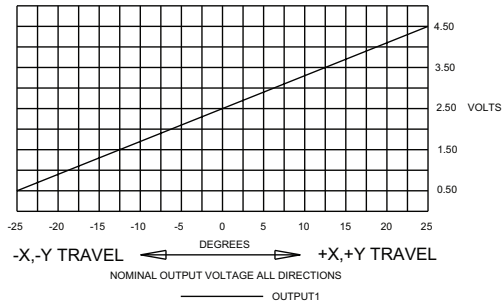

**OPTION BB & BT**

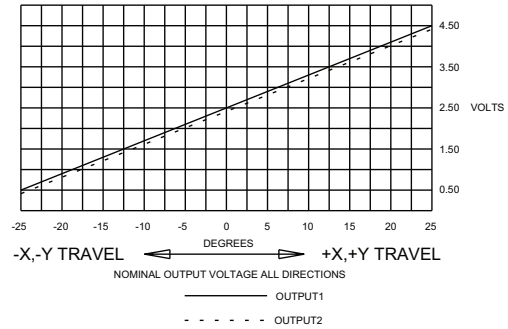

**OPTION CC & CT**

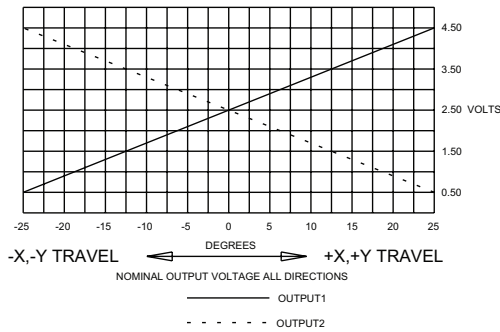

**OPTION DD & DT**

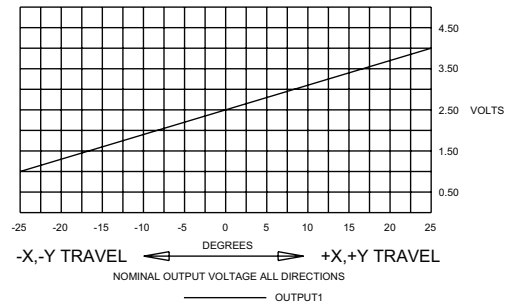

**OPTION EE & ET**

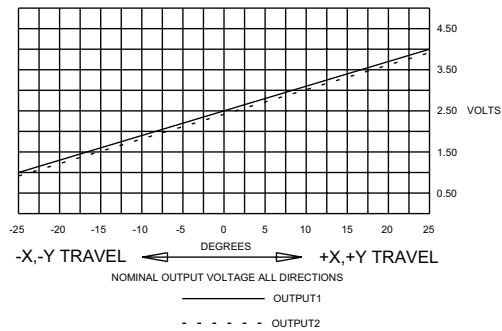

**OPTION FF & FT**

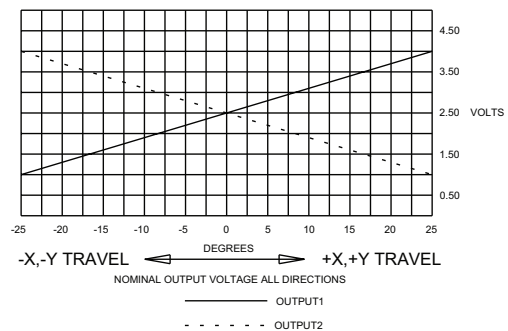

**OPTION GG**

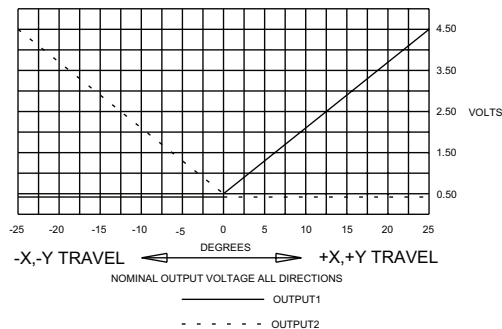

**OPTION HH**

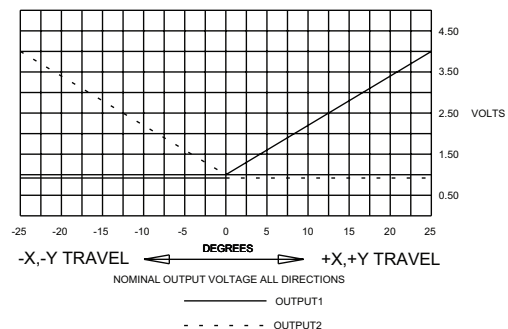

HALL EFFECT



## BUTTON CONFIGURATIONS

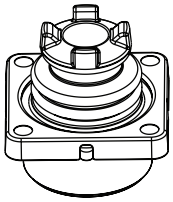

BUTTON STYLE 1  
(CASTLE)

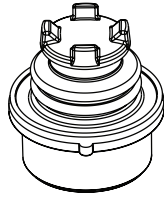

BUTTON STYLE 2  
(EXTERNAL CASTLE BOOT)

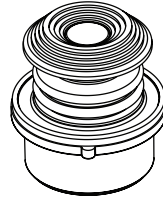

BUTTON STYLE 3  
(SHORT DOUBLE STADIUM)

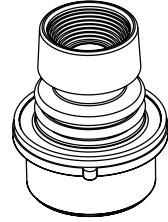

BUTTON STYLE 4  
(TALL CONCAVE STADIUM)

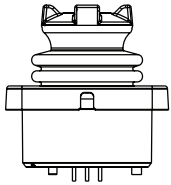

BUTTON STYLE 5  
(EXTERNAL BAT  
HANDLE BOOT)

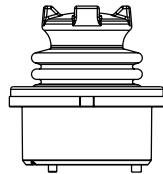

BUTTON STYLE 6  
(EXTERNAL SMOOTH BOOT)

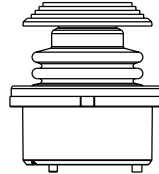

BUTTON STYLE 7  
(LONG CONCAVE Y AXIS BUTTON)

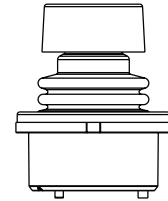

BUTTON STYLE 8  
(LOW PROFILE BUTTON)  
(AVAILABLE FOR HTL2 ONLY)

