

FINGER JOYSTICK WITH PUSHBUTTON OPTION

HTLT
HALL EFFECT
FINGER JOYSTICK

3 MILLION CYCLE MECHANICAL LIFE, PUSHBUTTON OPTION



HTLT4 with
Center Pushbutton

OTTO's HTLT Series miniature Hall effect joystick is a proportional linear output finger joystick with a pushbutton option. With a lower base price than the HTL, the HTLT features 6 different button styles, multiple output configurations and 3 mounting options including top mount with threaded housing.

Gating options include omnidirectional square on axis guided feel, gated single axis return to center, gated dual axis return to center and omnidirectional round smooth feel. The HTLT offers excellent tactile feedback and is available with a mechanical seal of either dusttight or watertight per IP68S. All electronics are sealed to IP68S.

Featuring contactless Hall effect technology, the HTLT is designed to withstand harsh environments and works well in the industrial, medical, unmanned vehicle and off-highway industries for applications such as remote controls, armrest integration, control panels and belly boxes.

Features:

- **One/two axis gated or 360°**
- **Pushbutton option**
- **Electronics sealed to IP68S**
- **Dusttight or Watertight per IP68S**
- **3.3V SPI output option**
- **Single or redundant analog output options**
- **PWM output option**
- **3 million cycle mechanical life**
- **Tested for harsh environments**
- **Great for industrial, medical, unmanned vehicle and off-highway industries**

Standard Characteristics/Ratings:

ELECTRICAL RATINGS:

Joystick: Rated at Vcc = 5V @ 20°C Load = 1mA (4.7KΩ)

Electrical	Units	Min	Typ	Max
Supply Voltage	VDC	4.50	5.00	5.50
Output Voltage Tolerance at Center	VDC @ 5V Vcc	-25	N/A	+25
Output Voltage Tolerance at Full Travel	VDC @ 5V Vcc	-25	N/A	+25
Supply Current Outputs "AA" & "DD" B=0, Vcc=5V, Io=0	mA	N/A	10.00	12.00
Supply Current Outputs "BB", "CC", "EE", "FF", "GG" & "HH" B=0, Vcc=5V, Io=0	mA	N/A	20.00	24.00
Output Impedance	kΩ	N/A	1.00	N/A

Pushbutton Circuit: Normally Open Logic Level

MECHANICAL RATINGS

Joystick: **Mechanical Life All Directions** 3,000,000 Cycles

Mechanical	Units	Min	Typ	Max
Travel Angle	Degrees	19.0	20.0	21.0
Over Travel Angle	Degrees	0.5	1.0	1.5
Operating Force (w/ Boot) at Top of Button, @ 20° C	OZ	5.0	8.0	16.0
Max Allowable Vertical Force on Button	LBS	N/A	N/A	25.0
Max Allowable Radial Force on Top of Knob	LBS	N/A	N/A	25.0
Max Allowable Torque on Button About Shaft Axis	IN-LBS	N/A	N/A	5.5

Pushbutton:

Mechanical Life		3,000,000 Cycles		
Operating Force @ 20° C	OZ	6.0	8.0	10.0

ENVIRONMENTAL:

Operating Temperature:	° C	-40	20	85
-------------------------------	-----	-----	----	----

Joystick:

Electronics Seal	ISO 20653, Dusttight or watertight per IP68S			
Drop	1 Meter Max. to Concrete			
EMI/RFI Withstand	Per SAE J1113, Contact Factory for Details			

Pushbutton:

Seal	ISO 20653, Dusttight or watertight per IP68S			
------	--	--	--	--

ELECTRONICS

Seal Integrity:	Electronics IP68S			
------------------------	-------------------	--	--	--

MATERIALS:

Housing:	Thermoplastic, black			
Button:	Thermoplastic, black			
Flange:	Thermoplastic, black			
Bellows:	Silicone, black			
Pushbutton Wires:	24 AWG			

Mounting Hardware: 1-27 Hex nut (.09 Thick) included (with threaded base)
Recommended max torque = 7 IN-LBS.
or 4x #4-40 x .38 screws with square mounting flange

3 MILLION CYCLE MECHANICAL LIFE, PUSHBUTTON OPTION

HTLT2 PART NUMBER CODE

HTLT2 - X	X	X	X	X	X	XX	X	X	
Button Style	Case Style	Seal*	Travel	Gating	Operating Force	Output 1 ①	Output 2 ②	Termination	Button Color
<ol style="list-style-type: none"> Castle External Castle Boot Short Double Stadium Tall Concave Stadium External Bat Handle Boot External Castle Boot with Pushbutton 	<ol style="list-style-type: none"> 1-27 Thread 1" Smooth 	<ol style="list-style-type: none"> Dusttight Watertight** 	<ol style="list-style-type: none"> 1.20° 	<ol style="list-style-type: none"> Single Axis Return to Center 	<ol style="list-style-type: none"> 1.16 oz 	<ol style="list-style-type: none"> AA. 2.5 +/- 2.0VDC BB. 2.5 +/- 2.0VDC CC. 2.5 +/- 2.0VDC DD. 2.5 +/- 1.5VDC EE. 2.5 +/- 1.5VDC FF. 2.5 +/- 1.5VDC GG. 0.5 - 4.5VDC HH. 1.0 - 4.0VDC JJ. SPI, 3.3V Supply KK. SPI, 5V Supply 	<ol style="list-style-type: none"> NONE 2.5 +/- 2.0VDC 2.5 +/- 2.0VDC NONE 2.5 +/- 1.5VDC 2.5 +/- 1.5VDC 0.5 - 4.5VDC 1.0 - 4.0VDC None None 	<ol style="list-style-type: none"> Wire Leads 22 AWG UL 1569*** Wire Leads 24 AWG SAE AS22759*** 	<ol style="list-style-type: none"> Black

* Electronics sealed to IP68S.

** Watertight panel sealed option available with button styles 2, 5 and 8.

*** Pushbutton wire leads are 24 AWG, SAE AS22759.

① Outputs are from the center to the full travel position in each direction. Options "AA", "BB", "CC", "DD", "EE" and "FF" provide increased voltage in +Y and decreasing voltage in -Y. Direction from one output per axis. Options "GG" and "HH" provide increasing voltages in all directions (+Y -Y) from 2 outputs per axis.

② Options "BB" and "EE" provide redundant output 2 which duplicates output 1. Options "CC" and "FF" provide redundant output 2 which is inverse of output 1.

HTLT4 PART NUMBER CODE

HTLT4 - X	X	X	X	X	X	XX	X	X	
Button Style	Case Style	Seal*	Travel	Gating	Operating Force	Output 1 ①	Output 2 ②	Termination	Button Color
<ol style="list-style-type: none"> Castle External Castle Boot Short Double Stadium Tall Concave Stadium External Bat Handle Boot External Castle Boot with Pushbutton 	<ol style="list-style-type: none"> 1-27 thread 1" smooth 	<ol style="list-style-type: none"> Dusttight Watertight*** 	<ol style="list-style-type: none"> 1.20° 	<ol style="list-style-type: none"> Omnidirectional; Square on Axis Guided Feel Gated; Two Axis Return to Center Omnidirectional; Square; Smooth Feel 	<ol style="list-style-type: none"> 1.16 oz 	<ol style="list-style-type: none"> AA. 2.5 +/- 2.0VDC BB. 2.5 +/- 2.0VDC CC. 2.5 +/- 2.0VDC DD. 2.5 +/- 1.5VDC EE. 2.5 +/- 1.5VDC FF. 2.5 +/- 1.5VDC GG. 0.5 - 4.5VDC HH. 1.0 - 4.0VDC JJ. SPI, 3.3V Supply KK. SPI, 5V Supply 	<ol style="list-style-type: none"> NONE 2.5 +/- 2.0VDC 2.5 +/- 2.0VDC NONE 2.5 +/- 1.5VDC 2.5 +/- 1.5VDC 0.5 - 4.5VDC 1.0 - 4.0VDC None None 	<ol style="list-style-type: none"> Wire Leads 22 AWG UL 1569*** Wire Leads 24 AWG SAE AS22759*** 	<ol style="list-style-type: none"> Black

* Electronics sealed to IP68S.

** Watertight panel sealed option available with button styles 2, 5 and 8.

*** Pushbutton wire leads are 24 AWG, SAE AS22759.

① Outputs are from the center to the full travel position in each direction. Options "AA", "BB", "CC", "DD", "EE" and "FF" provide increased voltage in +X, +Y and decreasing voltage in -X, -Y. Direction from one output per axis. Options "GG" and "HH" provide increasing voltages in all directions (+X, +Y, -X, -Y) from 2 outputs per axis.

② Options "BB" and "EE" provide redundant output 2 which duplicates output 1. Options "CC" and "FF" provide redundant output 2 which is inverse of output 1.

Button Style Configurations

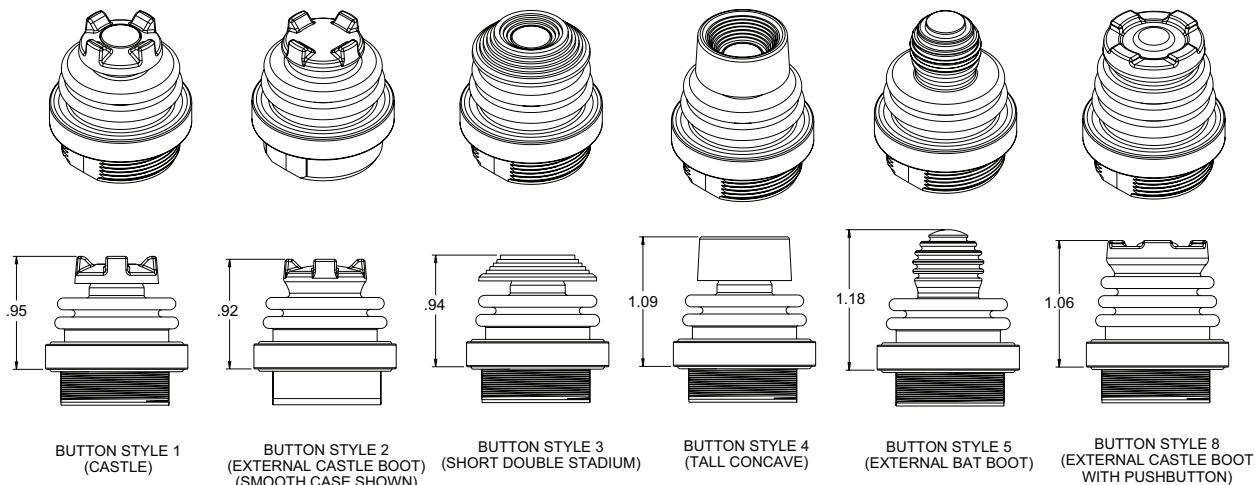

FINGER JOYSTICK WITH PUSHBUTTON OPTION

3 MILLION CYCLE MECHANICAL LIFE, PUSHBUTTON OPTION

HTLT2

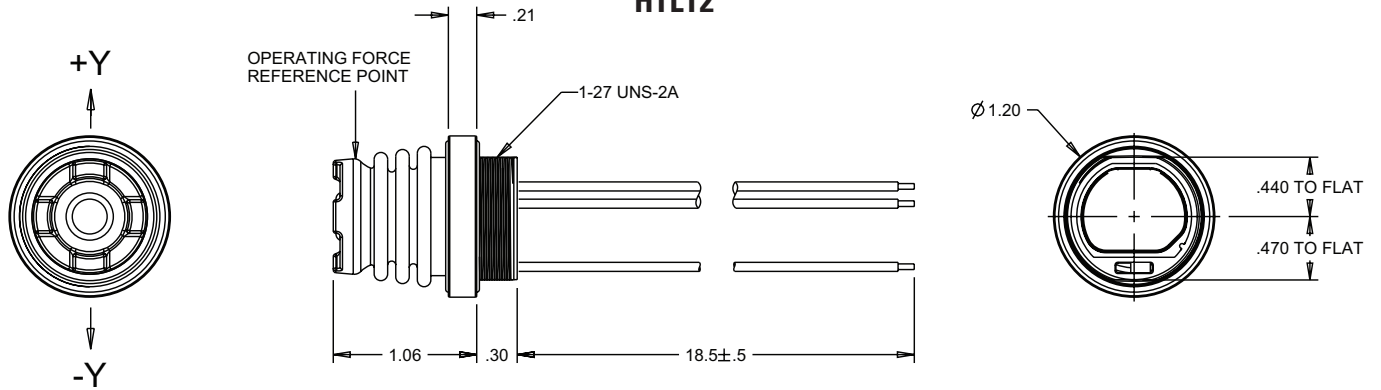

HTLT4

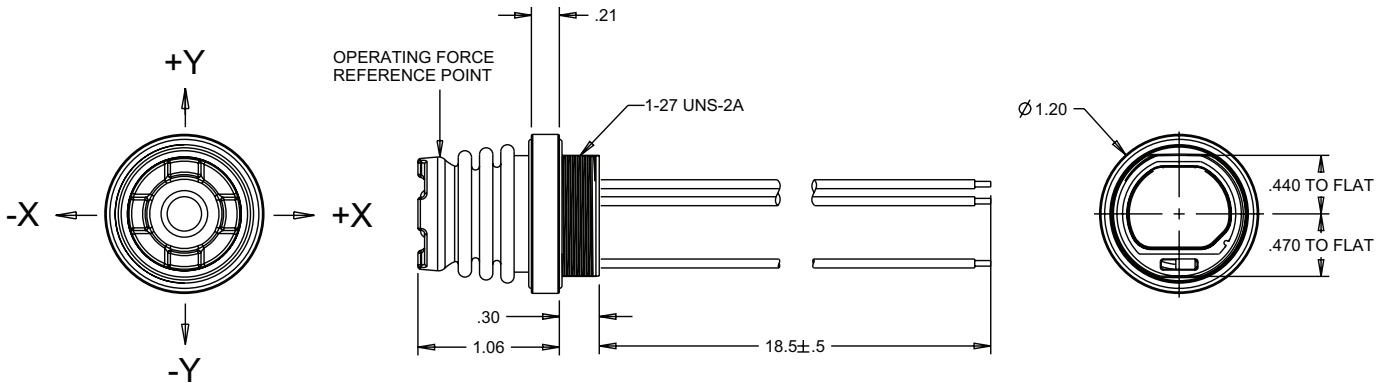

HTLT2 and HTLT4 Panel Footprint

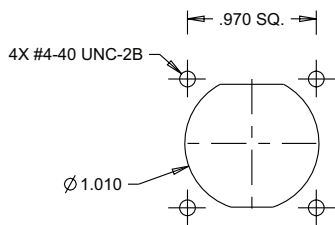

SUGGESTED PANEL OPENING WHEN USING FLANGE AND SCREWS.

MAX. PANEL THICKNESS OF 0.125 FOR BOTTOM MOUNT

MIN. PANEL THICKNESS OF .100 FOR TOP MOUNT

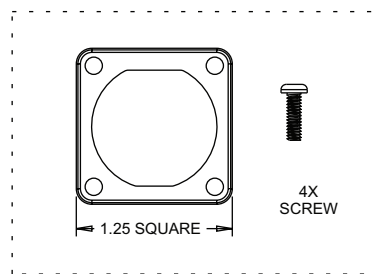

1" SMOOTH CASE STYLE HARDWARE SHIPPED UNASSEMBLED

OR

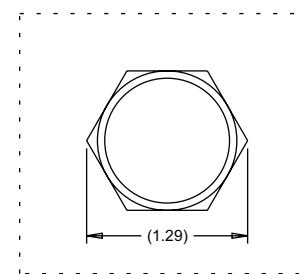

1-27 THREAD CASE STYLE HARDWARE SHIPPED UNASSEMBLED

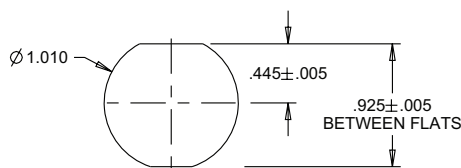

SUGGESTED PANEL OPENING WHEN USING 1-27 NUT.

MAX. PANEL THICKNESS OF 0.125

HTLT4 Gating Icons



Omnidirectional;
Square On-Axis
Guided Feel
(defined by shading)

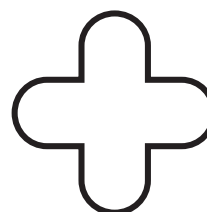

Gated;
Two Axis
Return to Center

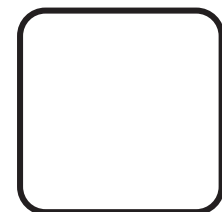

Omnidirectional;
Square;
Smooth Feel

FINGER JOYSTICK WITH PUSHBUTTON OPTION

3 MILLION CYCLE MECHANICAL LIFE, PUSHBUTTON OPTION

HTLT4

OPTION AA

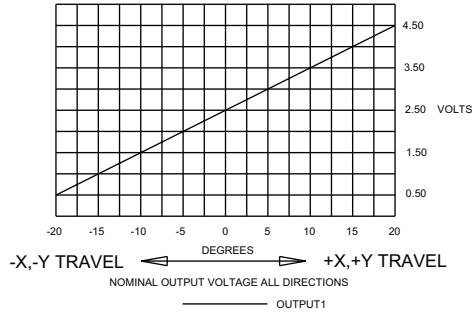

OPTION BB

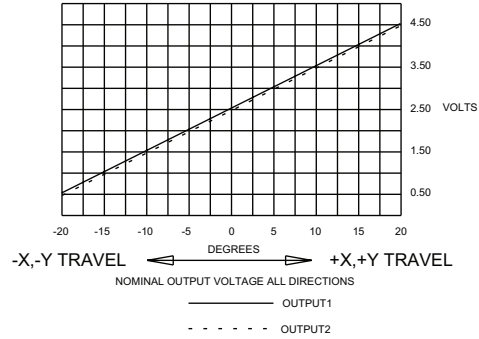

OPTION CC

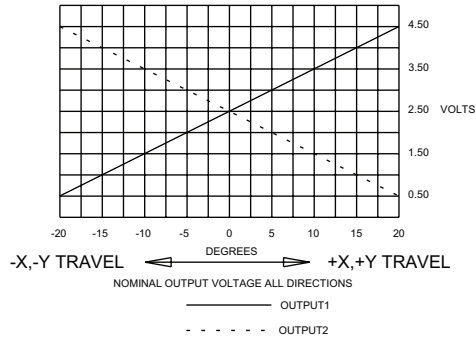

OPTION DD

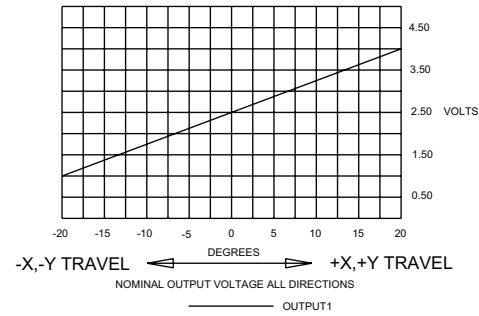

OPTION EE

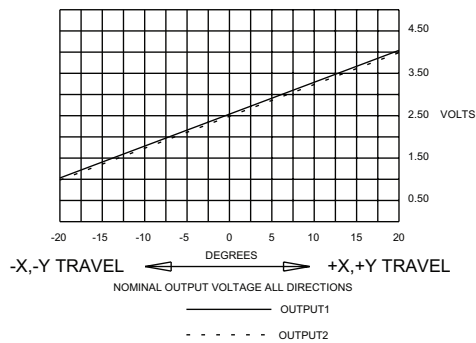

OPTION FF

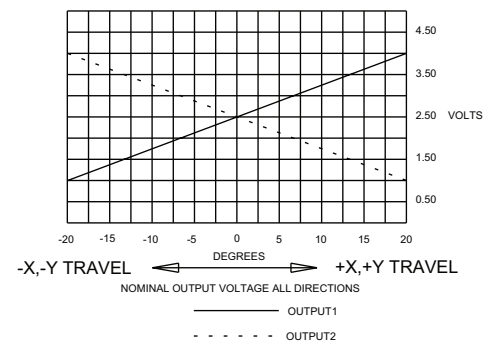

OPTION GG

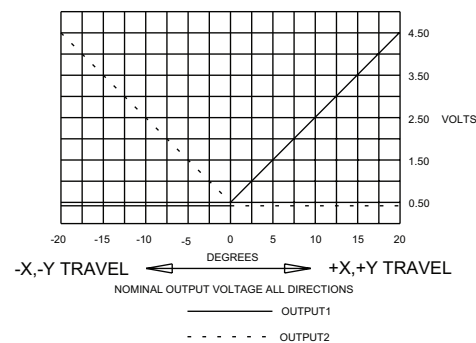

OPTION HH

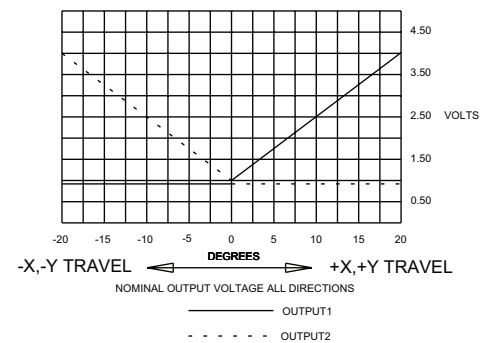

HALL EFFECT