

RUGGED DESIGN

Cast from aluminum alloy, the G2 Commander Grip is a rugged industrial control grip suitable for demanding applications. The standard G2 Commander Grip offers nine different faceplate configurations that include pushbutton, toggle, transducer, split trim and Hall effect switches. Thousands of custom faceplate configurations are possible. The grip body has 10 possible switch location options.

The G2 Commander Grip is suitable for use in military, aerospace and industrial applications, and is the ideal solution where durability and dependability are required.

- **Standard design eliminates the need for tooling charges**
- **Available as a fixed grip or can be mounted on an OTTO JH or JHM series Hall effect joystick**
- **Various mounting & termination options available**
- **Nine standard faceplate configurations that include OTTO's T3, T4 and T5 toggle switches, P4, P7 and P9 pushbutton switches, K1 rocker switches, SPT split trim switches, J2 transducer switches, FG flip guards, and HTWM, HTL and HTLT Hall effect switches.**
- **Thousands of custom faceplate configurations possible that can accommodate virtually all OTTO pushbutton, rocker, toggle, trim, transducer and thumbwheel switches**
- **Operator presence and trigger options**
- **USB output option**
- **Tested to withstand a 265 lb. load**
- **Grip sealed to IP68S (subject to change based on switch choice)**



Commander Grip with Brow Shown

Standard Physical Characteristics:

MATERIALS:

Handle: Aluminum, investment cast, A356-T6

Faceplate: Aluminum, wrought, 6061-T6

Wires: 22 AWG per M22759/11-22

G2 COMMANDER GRIP PART NUMBER CODE

G2	-	X	X	XX	X	X	X	X	X	X	X
Trigger With Guard	Operator Presence	Faceplate Option*	Grip Head Brow	Grip Head Switches Back	Grip Head Switches Top	Grip Head Switches Side*	Handle Switches	Cable Output	Paint		
1. None 2. Yes	1. None 2. Yes	AA AB AC AD AE AF AG AH AJ	1. None 2. Yes	1. None 2. One P7 Back Left 3. One P7 Back Right 4. Two P7's - Back Left & Right	1. None 2. One P7 Top Left 3. One P7 Top Right 4. Two P7's - Top Left & Right	1. None 2. One P7 Side Left 3. One P7 Side Right 4. Two P7's - Side Left & Right	1. None 2. One P7 Side Left 3. One P7 Side Right	1. Flying Leads 3' 2. USB**	1. Polyurethane Per MIL-DTL-53039, Color Black #37038 Per FED-STD-595 2. Powder Coat, Color Black #37038 Per FED-STD-595		

* See Faceplate Configurations on Page 28-29.

Faceplate options AB, AD and AH not available with grip head switches side, option 2 & 4.

Faceplate options AE and AF not available with grip head switches side, option 3 & 4.

**Faceplate options AC and AF not available with USB Cable Output option.

RUGGED DESIGN

STANDARD DIMENSIONS

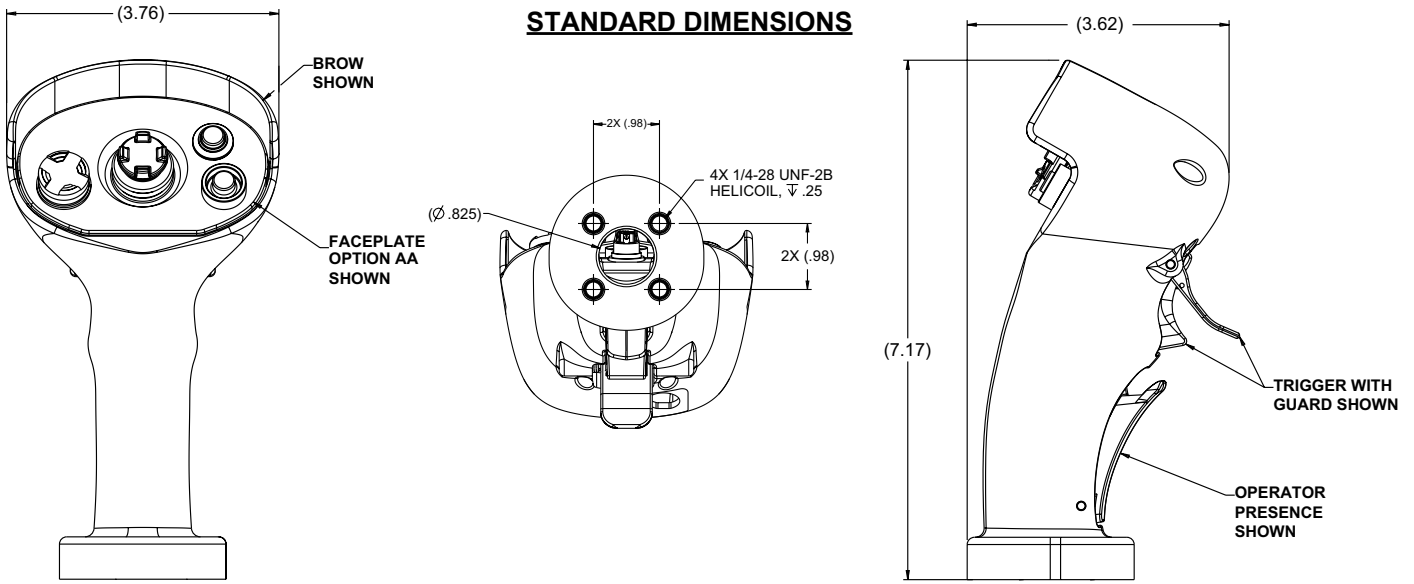

GRIP HEAD AND HANDLE SWITCH OPTIONS

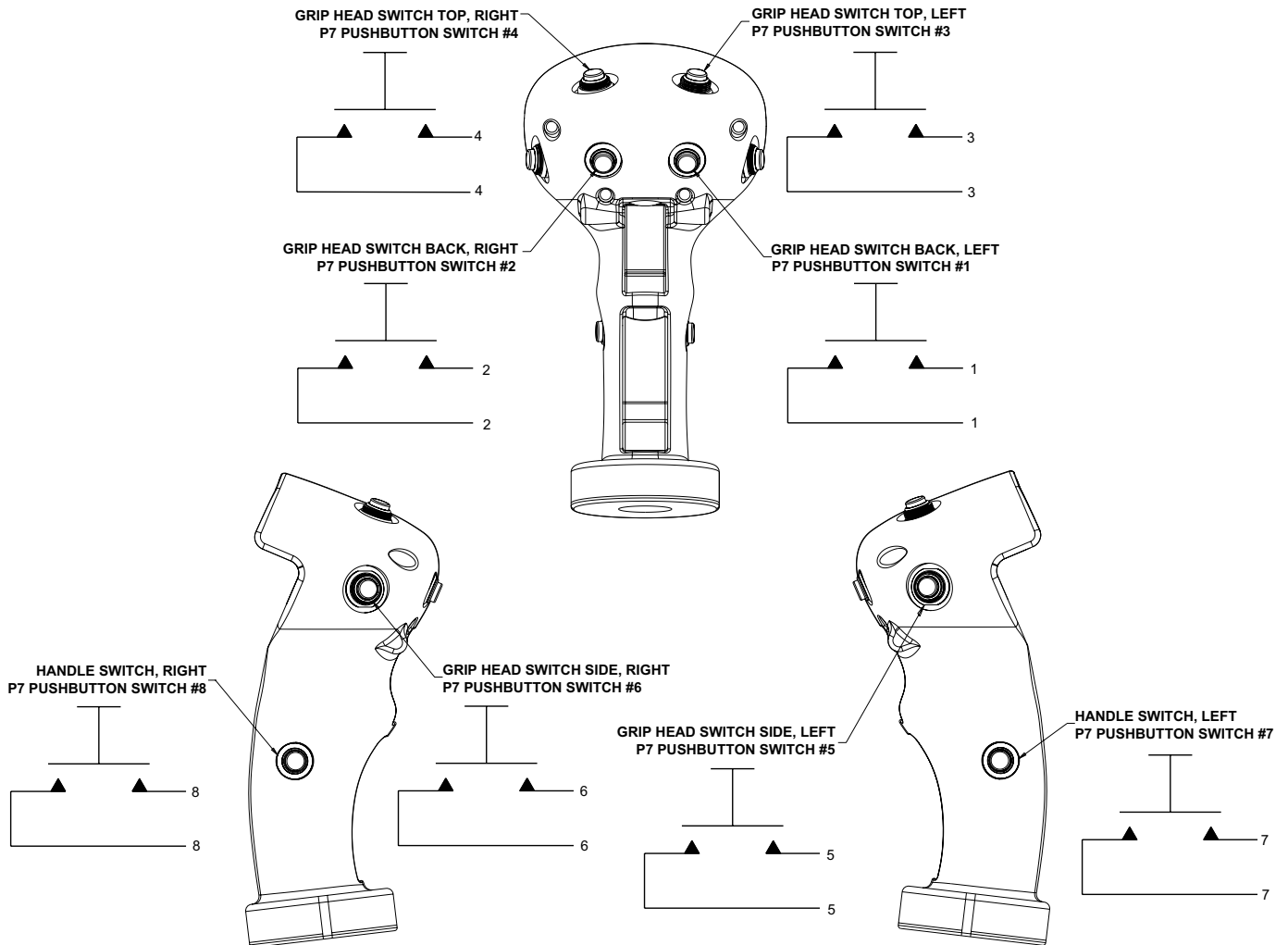

TRIGGER, BROW AND OPERATOR PRESENCE OPTIONS

TRIGGER OPTIONS

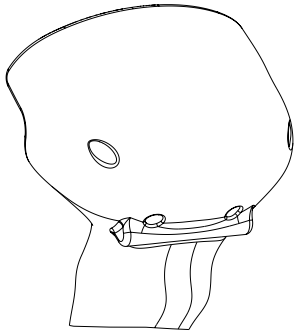

NO TRIGGER

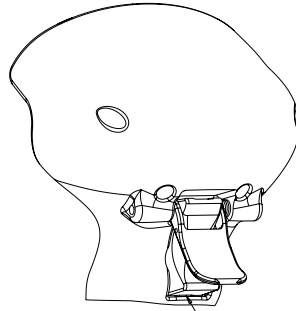

P4 PUSHBUTTON SWITCH

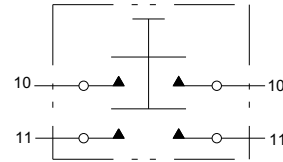

TRIGGER WITH GUARD

OPERATOR PRESENCE OPTIONS

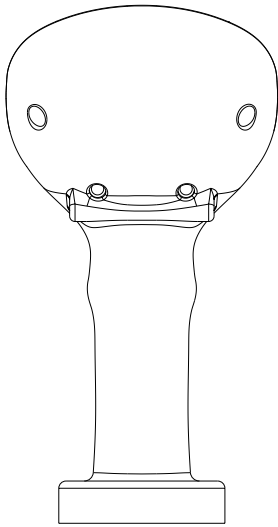

NO OPERATOR PRESENCE

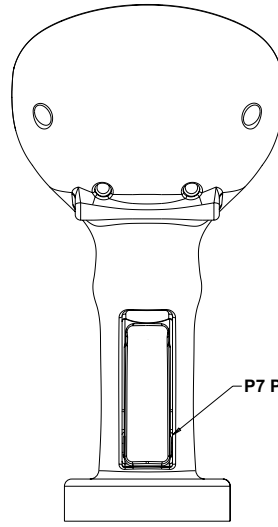

OPERATOR PRESENCE

P7 PUSHBUTTON SWITCH #9

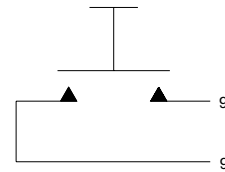

BROW OPTIONS

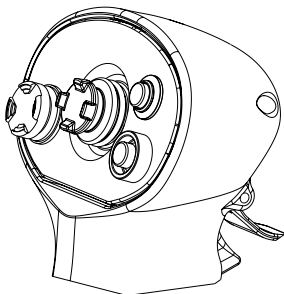

NO BROW

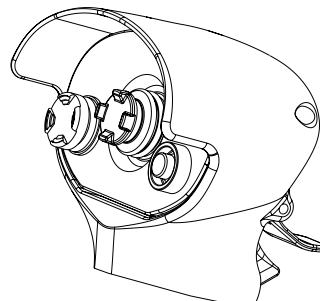

WITH BROW

STANDARD CONFIGURABLE FACEPLATE OPTIONS

FACEPLATE OPTIONS

HTL4 HALL EFFECT SWITCH

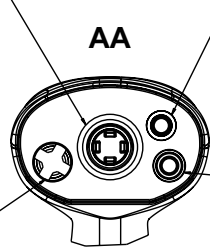
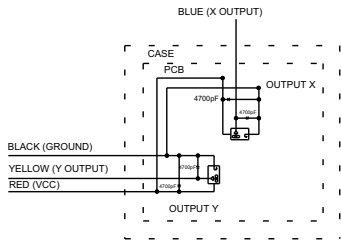

P7 PUSHBUTTON SWITCH

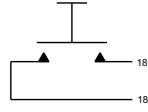

P7 PUSHBUTTON SWITCH

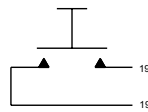

T5 TOGGLE SWITCH

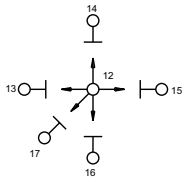

HTL4 HALL EFFECT SWITCH

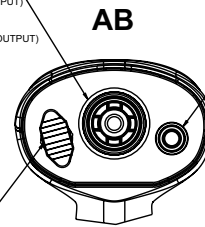
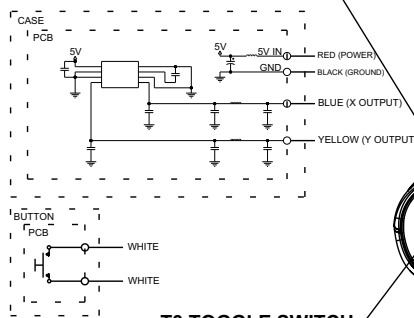

P7 PUSHBUTTON SWITCH

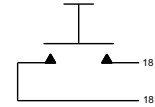

T3 TOGGLE SWITCH

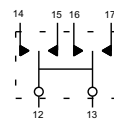

J2 TRANSDUCER SWITCH

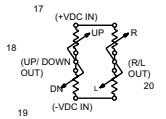

AC

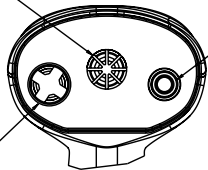

P7 PUSHBUTTON SWITCH

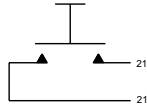

T4 TOGGLE SWITCH

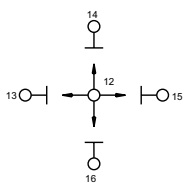

T5 TOGGLE SWITCH

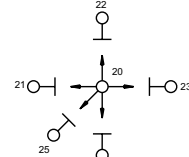

AD

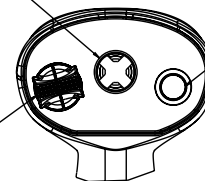

P9 PUSHBUTTON SWITCH

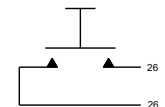

SPT SPLIT TRIM SWITCH

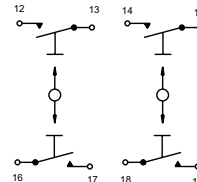

STANDARD CONFIGURABLE FACEPLATE OPTIONS

FACEPLATE OPTIONS

