

8-WAY MOMENTARY TOGGLE WITH TACTILE RESPONSE

Tactile switches remain a favorite among design engineers because the positive detent indicates circuit transfer to the operator. The T8-T toggle switch provides an 8-way momentary toggle action with detent providing a positive click action. The T8-T series provides Commercial and Military grade switching with a positive click action, ideal for grip applications in aircraft and off-road equipment.

Features:

- Positive detent
- 8-way momentary toggle action
- Positive click action
- Low level switching
- Available in Commercial & Military grades
- Variety of button styles & colors available
- RoHS/WEEE/Reach compliant
- Water resistant per MIL-STD-810F; method 506.4, procedure 3 (drip)



Castle Button Style

Standard Characteristics/Ratings:	
ELECTRICAL RATINGS:	
Load	Sea Level @ 28VDC
Resistive	2A
Inductive	1A
DWV	1050Vrms
Low Level	10mA @ 30mV
Electrical Life:	30,000 cycles
Mechanical Life:	150,000 cycles
Seal:	Water resistant per MIL-STD-810F, method 506.4, procedure 3 (drip)
Operating Temp Range:	-55°C to +85°C
Operating Force:	0.75 lb. +/- 0.25 lb.
Overtravel:	1.5° min
Pretravel:	9.5° max
Return Point:	4° min
MATERIALS:	
Case:	Thermoplastic
Button:	Thermoplastic
Terminals:	Beryllium copper or brass Gold over silver for low level
Mounting Hardware:	None provided

T8-T PART NUMBER CODE

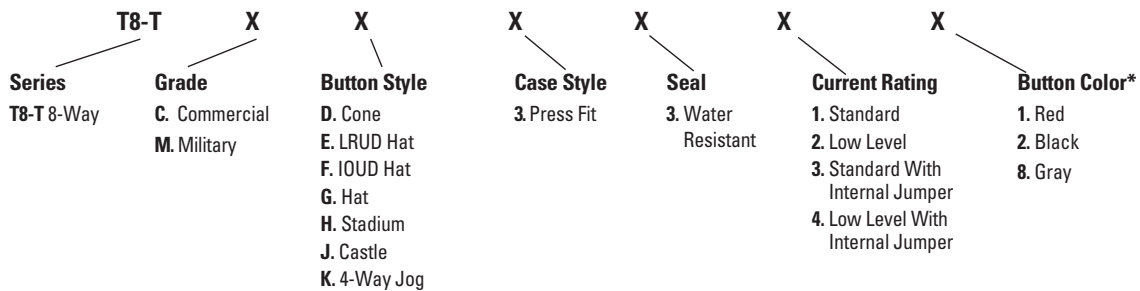

*Contact factory for additional colors.

T8-T TACTILE MINI TRIM

MT
T8-T TACTILE
MINI TRIM

8-WAY MOMENTARY TOGGLE WITH TACTILE RESPONSE

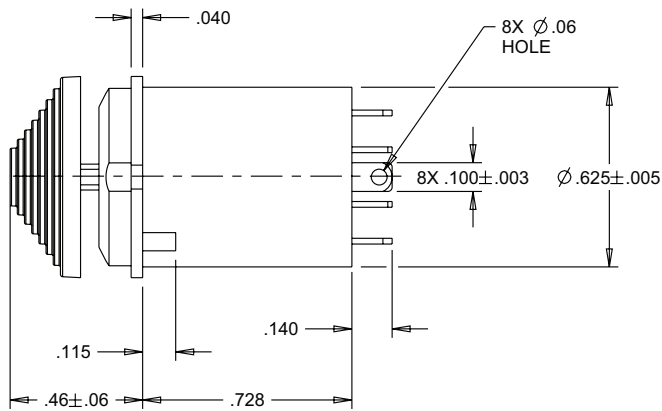

(Tall Hat Button Shown)

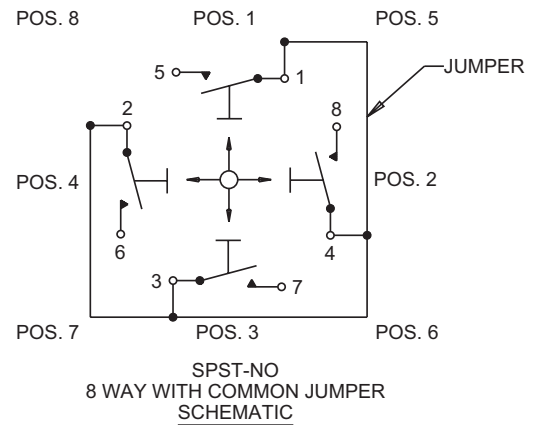
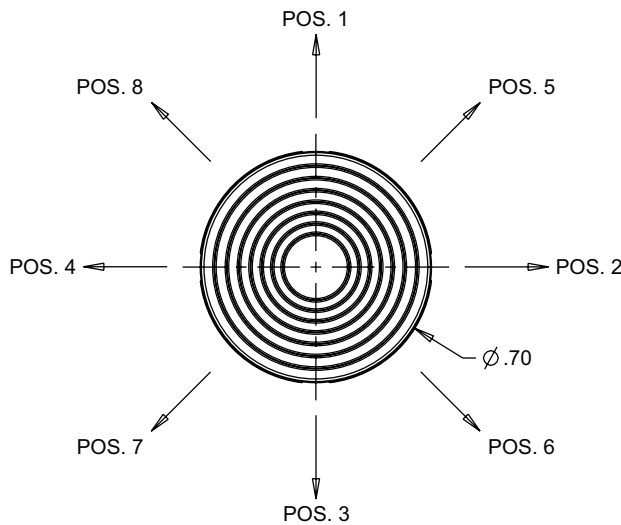
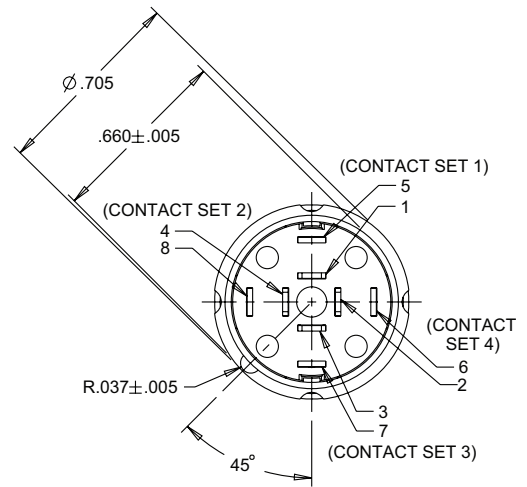

BUTTON POSITION/SWITCH ACTION (ALL MOMENTARY CONTACTS - ALL OTHER CONTACT SETS NOT SHOWN ARE OPEN)

BUTTON POSITION	CONTACT SET 1	CONTACT SET 2	CONTACT SET 3	CONTACT SET 4
1	5 —> 1			
2		8 —> 4		
3			7 —> 3	
4				6 —> 2
5	5 —> 1	8 —> 4		
6		8 —> 4	7 —> 3	
7			7 —> 3	6 —> 2
8	5 —> 1			6 —> 2

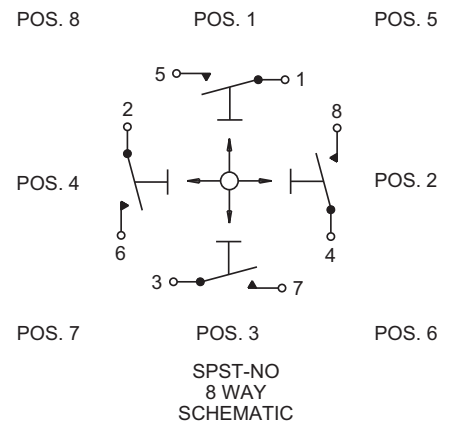

T8-T Mini Trim Button Styles

D - CONE

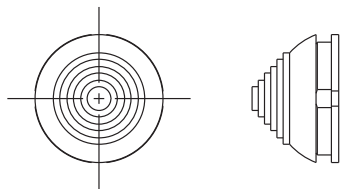

E - LRUD HAT

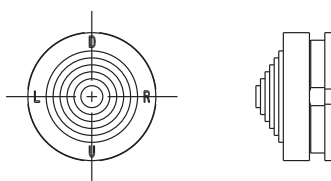

F - IOUD HAT

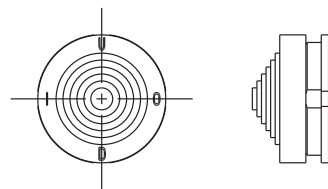

G - HAT

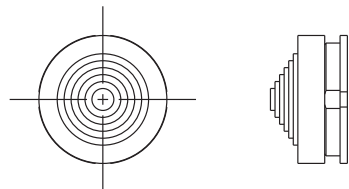

H - STADIUM

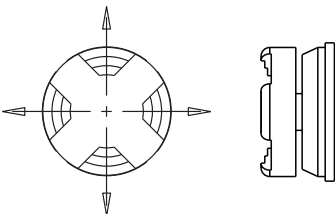

J - CASTLE

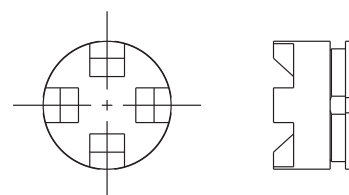

K - 4-WAY JOG

